

Switching Effect in Transverse Thermopower in Bi Microwires

Leonid KONOPKO^{1,2}

¹*Institute of Electronic Engineering and Nanotechnologies “D. Ghitu”, AS of Moldova*

²*International Laboratory of High Magnetic Fields and Low Temperatures, Wrocław, Poland
leonid.konopko@iieti.asm.md*

Abstract — At room temperature We have investigated the transverse thermopower in thin single-crystal bismuth microwires. The single-crystal nanowire samples in the diameter range 2 - 15 μm were prepared by the high frequency liquid phase casting in a glass capillary using an improved Ulitovsky technique; they were cylindrical single-crystals with (1011) orientation along the wire axis. In this orientation, the wire axis makes an angle of 19.5° with the bisector axis C_1 in the bisector-trigonal plane. Bismuth microwire was placed between two polished aluminum plates, which were at different temperatures. At relative displacement of the plates the microwire was rotated around its axis. Transverse thermoelectric power varied by rotating microwires. The maximum thermoelectric power ($S_{max} \sim 200 - 600 \mu\text{V/K}$ at the length of the plates $L = 4.5$ cm) occurred at the direction of the transverse temperature gradient along the C_3 axis. For the first time significant difference was found in the values of the thermoelectric power after turning microwires at 180 degrees (i.e. when the direction of the temperature gradient is reversed). The value of this switching effect, defined by us as $(S_{max} - S_{min}) / (S_{max} + S_{min})$, depends on the diameter d microwire and varies from 0.4 (for microwires with $d = 14 \mu\text{m}$) to 0.75 for microwires with $d = 5 \mu\text{m}$. Different assumptions about the nature of the observed effect will be discussed.

Index Terms — anisotropic thermoelement, microwire, switching effect, thermogenerator, transverse thermopower

I. INTRODUCTION

There are many reasons we are looking towards alternative energy sources. Using alternative energy helps to preserve many of the natural resources that currently used as sources of energy. As a source of heat for thermoelectric generators (the thermoelectric method of thermal energy conversion into electric energy) involves unconventional renewable sources of thermal energy: from solar energy to the heat of human body. [1,2] Currently, for thermoelectric conversion of heat most widely used approach based on the Seebeck and Peltier effects created at the interface of two materials with different values of the Seebeck coefficient. Such devices are commonly referred to as a thermocouple. [3] Along with its benefits, this thermocouple also has some disadvantages, for example, to obtain the required electrical voltage, they must be connected in series circuits, which leads to the design complexity and reduce reliability. Technological and operational difficulties at the joins between the n-and p-type thermocouple material motivate the search for alternative thermoelectric power converters. One such converter, devoid of the above disadvantages, is the anisotropic thermoelement (AT) using anisotropy of thermoelectric power. The appearance of new more efficient materials for anisotropic thermoelements is reviving interest in the transverse thermoelectric effect. The principle of operation and the features ATs were extensively studied both in scientific and applied aspects [4-6]. A transverse AT, as a voltage source in measuring

systems, has some advantages:

(a) The thermopower, unlike a conventional thermocouple, is proportional to the temperature gradient $(T_1 - T_2)/h$ instead of the temperature difference $T_1 - T_2$. Thus, decreasing the width h , it is possible to increase voltage at the same temperature difference.

(b) Voltage V is proportional to length l ; thus, it is possible to increase voltage by increasing the length of the plate.

(c) To obtain voltage, we need no junctions that are required for increasing sensitivity. In the case of ATs, it is sufficient to increase the length of the crystal employed in order to enhance sensitivity.

In a homogeneous isotropic material difference in temperature creates a irrotational (potential) electric field. In materials with anisotropy of the thermopower, the temperature difference creates a transverse (perpendicular to the temperature gradient) the thermoelectric field. [7-9] Transverse thermoelectric field in contrast to the longitudinal, used in conventional thermocouples, may give rise to an electric current even in a uniform closed circuit. [9,10] Therefore, even the homogeneous thermoelectrically anisotropic medium can serve as a generator of the thermoelectric power, ie thermoelement. [11]

In the present paper we report measurements of transverse thermopower on a single crystal microwires of bismuth in a glass cover. Like in the case of “Umkehr effect” [12-15] (unexpected asymmetry in the magneto-Seebeck effect of Bi single crystals under sign reversal of the magnetic field), the transverse thermopower is strongly asymmetric when reversing the temperature gradient.

II. SAMPLES AND EXPERIMENT

We have studied the possibility of using a microwire of bismuth to design an anisotropic thermoelectric generator. Glass-coated single-crystal microwires of pure and Sn-doped bismuth were prepared by the Ulitovsky method; they were cylindrical single crystals with the $(10\bar{1}1)$ orientation along the wire axis; the C_3 axis was inclined at an angle of 70° to the wire axis. The technique described in [16,17] allows preparing single-crystal wires with

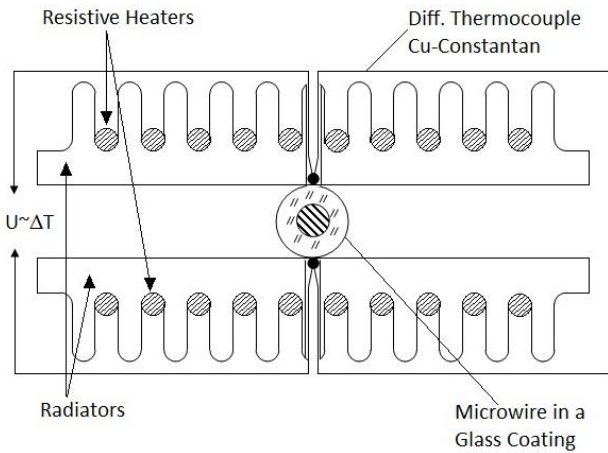

Fig. 1. Schematic drawing of the device for measuring transverse thermopower of the microwire in a glass coating.

diameters d from $50 \mu\text{m}$ to 40 nm . It is known that the size effect significantly changes the thermoelectric properties and leads to an increase in thermoelectric efficiency [18]. The developed technology allows obtaining a glass-coated single-crystal microwire of Bi and its alloys with Sn with a length up to a few meters and with a given diameter from $0.5 \mu\text{m}$ to $50 \mu\text{m}$.

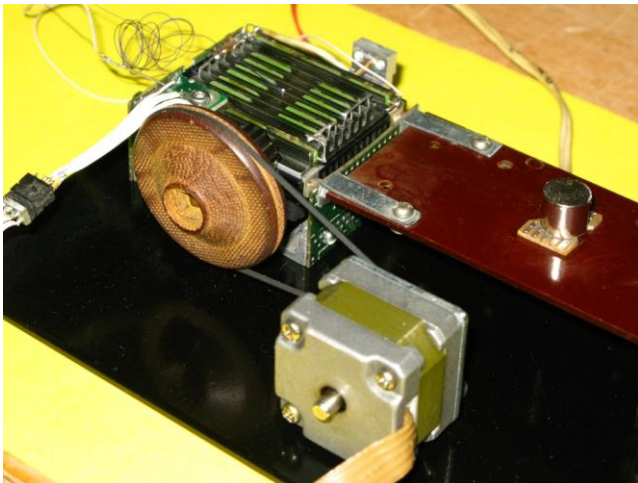

Fig. 2. Experimental set-up for measuring transverse thermopower of the microwire in a glass coating.

The transverse thermopower $S_{trans} = U/\Delta T$, where U is the voltage across the sample, ΔT is the transverse temperature gradient. To measure the transverse thermopower S_{trans} in microwire segments with a length of

10 cm, we made a special device consisting of two Al plates with different temperatures. A glass-coated microwire segment was placed between these plates in such a way as to keep good thermal contact between the glass cover of the microwire and the surface of the plates throughout the length of the microwire (Fig. 1). To obtain a uniform temperature gradient, resistive heaters were placed on the plates. The temperature gradient was measured by a differential copper-constantan thermocouple, two junctions of which were situated in the middle of the plates near the surfaces being in contact with the microwire. Displacement of plates relative to each other causes the rotation of the

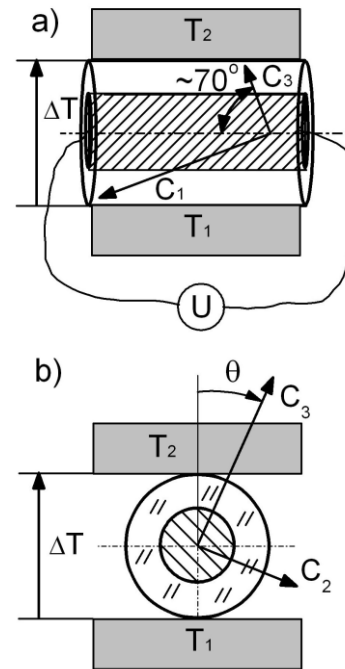

Fig. 3. Arrangement of the Bi microwire with crystallographic orientation $[10\bar{1}1]$ in the device for measuring transverse thermopower.

microwire, so we can record rotation diagrams of the transverse thermoelectric power on the direction of the temperature gradient. The presence of two heaters allows us to change the direction of the temperature gradient at a fixed microwire, and eliminates the inequality of the microwire's thermal contact with the surface of the plates during rotation of the microwire between the plates. Contacts to the microwires were made using liquid eutectic InGa, this method allowed us to eliminate twisting of the microwire during its rotation. In order to ensure uniformity of rotation of the microwire, the top plate is replaced with a small step screw pair, the screw is rotated by the step motor. Step motor controlled by a computer and a rotation angle of the microwire can be identified by the number of steps. The top plate is moved around 1 mm for 900 steps of the motor that provides high accuracy and smooth rotation of the microwire. To determine the orientation of the crystallographic axes of the microwire setup allows to record the rotation diagrams of microwire transverse magnetoresistance. For this purpose, aside from the plates there are two neodymium permanent magnets,

which create a transverse magnetic field ~ 0.2 T; at rotation of the microwire the changes of its resistance are recorded. Design of the set-up for measuring transverse thermopower of the microwire in a glass coating is shown at Fig. 2. Arrangement of the Bi microwire with crystallographic orientation $[10\bar{1}1]$ in the device for measuring transverse thermopower is shown at Fig. 3.

All measurements of the transverse thermopower of the microwires have been done at room temperature.

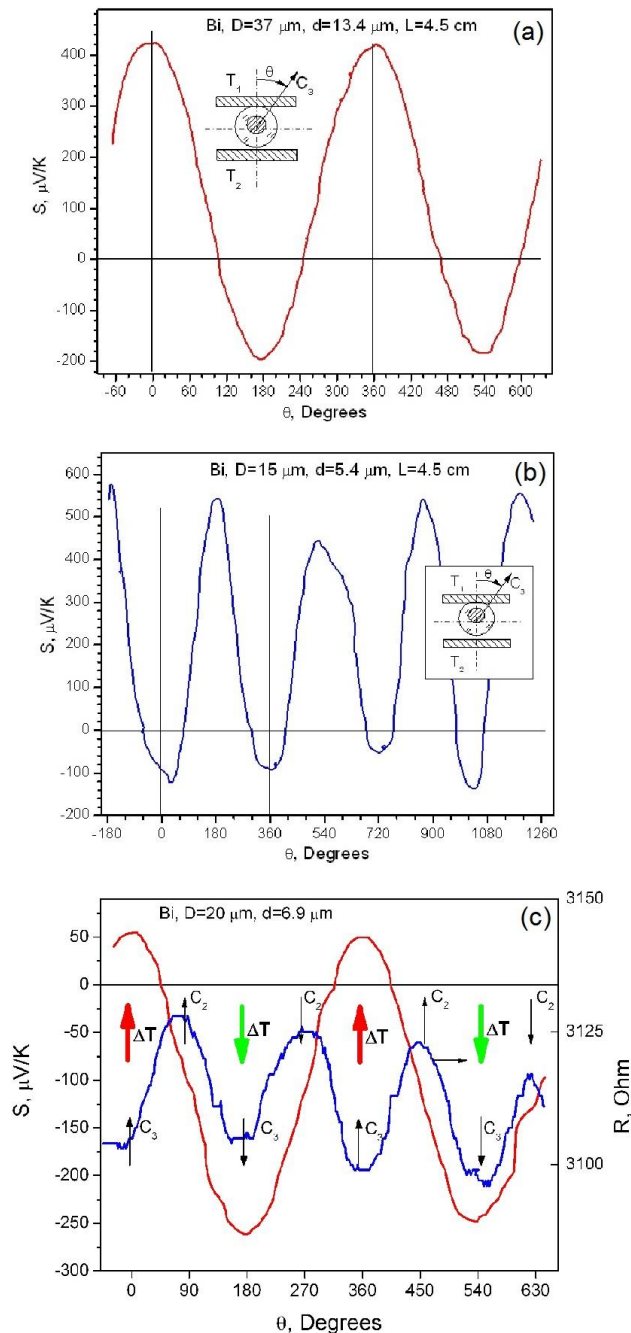

Fig. 4. The dependence of the transverse thermopower for Bi microwire on the rotation angle. (a): $D = 37 \mu\text{m}$, $d = 13.4 \mu\text{m}$; (b): $D = 15 \mu\text{m}$, $d = 5.4 \mu\text{m}$; (c): $D = 20 \mu\text{m}$, $d = 6.9 \mu\text{m}$; thin arrows indicate the position of the axes C_3 and C_2 on the rotation diagram of the magnetoresistance; thick arrows indicate the direction of the temperature gradient.

III. RESULTS AND DISCUSSION

Investigation of dependence of the transverse thermopower of bismuth microwires in glass coating on diameter of the microwire was done. Fig. 4 shows the results of measurements of three samples of Bi microwire: (a): $D = 37 \mu\text{m}$, $d = 13.4 \mu\text{m}$; (b): $D = 15 \mu\text{m}$, $d = 5.4 \mu\text{m}$; (c): $D = 20 \mu\text{m}$, $d = 6.9 \mu\text{m}$. Figures 3 and 4 (c) shows the location of the crystallographic axes relative to the transverse temperature gradient. From the diagrams of

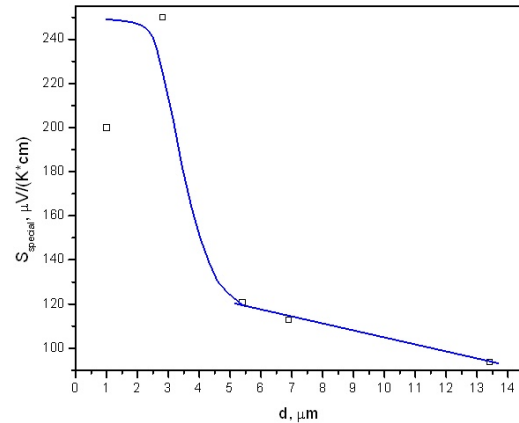

Fig. 5. The dependence of the transverse thermopower for Bi microwire on the microwire diameter.

rotation of transverse magnetoresistance is seen that the maximum transverse thermopower occurs when the temperature gradient is directed along the C_3 axis. In the process of optimizing of the parameters of the microwire based on Bi and Bi-0.05Sn for subsequent use in the anisotropic thermoelectric devices the best parameters were obtained in the microwire of Bi-0.05Sn ($D = 15 \mu\text{m}$, $d = 2.9 \mu\text{m}$), the specific thermopower $S_{\text{special}} = 250 \mu\text{V} / (\text{K} \cdot \text{cm})$. Fig. 5 shows the dependence of the transverse thermopower on the diameter of microwire core. It is seen that with decreasing diameter of the microwires the magnitude of the transverse thermopower increases. Resistance of the microwire increases with decreasing its diameter, which adversely affect the efficiency thermoelectric devices. For example, to obtain a thermoelectric voltage of 1 V at a temperature gradient of 5 K, we need to use a microwire with a diameter of $2 \mu\text{m}$ and a length of 8 m. The resistance of the microwire will be $R = 3 \text{ MOhm}$ and the maximum current of that generator will be equal to $0.34 \times 10^{-6} \text{ A}$.

When we investigated transverse thermopower in bismuth microwires in glass coating we have discovered a new effect, which consists of mismatch values of the thermopower when the direction of the temperature gradient is reversed, that is, when we turn the microwire to 180° . The value of this switching effect we defined as the ratio $(S_{\text{max}} - S_{\text{min}}) / (S_{\text{max}} + S_{\text{min}})$, where S_{max} and S_{min} - extreme values of the transverse thermopower which depends on the diameter of the microwires (Fig. 4). Fig. 6. shows the dependence of the switching effect for Bi microwire on the microwire diameter. For thin microwire ($d \sim 5 \mu\text{m}$) this effect reaches 70%. For proof of the effect we have stopped

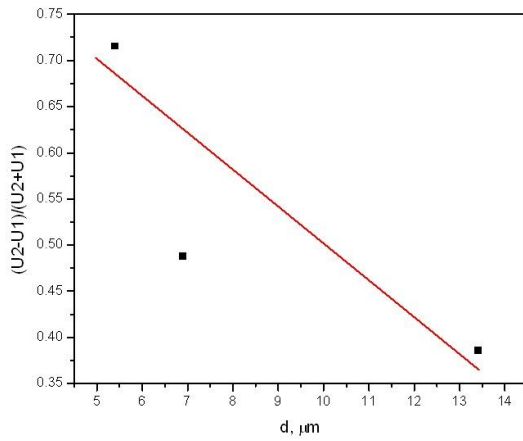

Fig. 6. The dependence of the switching effect for Bi microwire on the microwire diameter.

the rotation of microwire between the plates at the moment of maximum value of the transverse thermopower, and then changed the direction of the temperature gradient of by using the heater on the other plate. And in these conditions of the experiment, we have obtained the similar results.

It would be interesting to verify the existence of this effect in bulk samples. We have measured the transverse thermopower on bulk sample of bismuth with the same crystallographic orientation as in bismuth microwires, the direction of the temperature gradient varied switching the heaters. Fig. 7 shows the temperature dependence of the switching effect for bulk Bi sample 2.63x3.05x5 mm³ with [1011] crystallographic orientation (like in Bi microwires). Switching effect does not exceed 8%, but even in a bulk sample it exists.

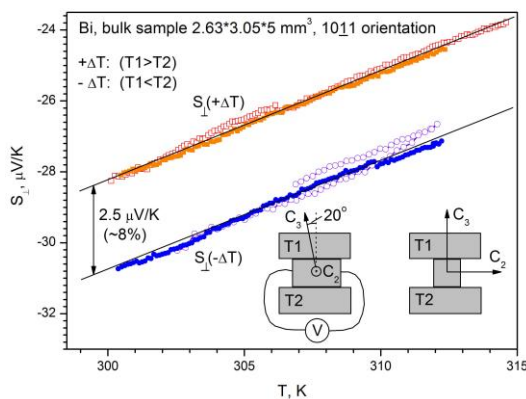

Fig. 7. The temperature dependence of the switching effect for bulk Bi sample 2.63x3.05x5 mm³ with [1011] crystallographic orientation (like in Bi microwires).

IV. CONCLUSION

At room temperature we have investigated the transverse thermopower in thin single-crystal bismuth microwires. Bismuth microwire was placed between two polished aluminum plates, which were at different

temperatures. At relative displacement of the plates the microwire was rotated around its axis. Transverse thermoelectric power varied by rotating microwires. The maximum thermoelectric power ($S_{max} \sim 200 - 600 \mu\text{V/K}$ at the length of the plates $L = 4.5 \text{ cm}$) occurred at the direction of the transverse temperature gradient along the C_3 axis. For the first time significant difference was found in the values of the thermoelectric power after turning microwires at 180 degrees (i.e. when the direction of the temperature gradient is reversed). The value of this switching effect depends on the diameter d microwire and varies from 0.4 (for microwire with $d = 14 \mu\text{m}$) to 0.75 (for microwires with $d = 5 \mu\text{m}$); for bulk Bi sample with the same crystallographic orientation this effect equal 0.08.

ACKNOWLEDGMENTS

This work was supported by the STCU Grant no. 5050 and ASM Project # 11.836.05.05A.

REFERENCES

- [1] D. Chinory, Solar Power Generator. The British petroleum Company Pic, Patent, BBH 17.09.86, MKI 24 2/04 H01 35/02, MKH F460.
- [2] Yu.S. Bortnikov et al., *Izv. Akad. Nauk SSSR. Energia i transport*, **5**, 3 (1961).
- [3] Rowe, D. M., ed Thermoelectrics Handbook:Macro to Nano. Taylor & Francis (2006)
- [4] P.I. Baranskii, I.S. Buda, I.V. Dakhovskii, A.G. Samoilovich, *Phys. Stat. Sol. (b)* **67**, 201 (1975).
- [5] A.A. Snarskii, A.M. Palti, and A.A. Ascheulov, *Fizika i Tekhnika Poluprovodnikov*, **31**, 1281 (1997) (in Russian).
- [6] A.R. Regel', G.A. Ivanov, V.M. Grabov, L. I. Anatyshuk, O. Ia. Luste, *Patent No. 245859* (1968).
- [7] A.G. Samoilovich and L.L. Korenblit, *UFN*, **49**, 243 (1953) (in Russian).
- [8] L.D. Landau, L.P. Pitaevskii, E.M. Lifshitz, *Electrodynamics of Continuous Media*, Butterworth-Heinemann, 1984.
- [9] W. Tomson, *Mathematical Physics Papers*, **1**, 248 (1882).
- [10] C. Herring. *Phys. Rev.* **59**, 889 (1941).
- [11] A.G. Samoilovich, L.L. Korenblit. Patent UK N 1088764 (1964).
- [12] E. Gruneisen, and J. Gielessen, *Ann. Phys. (Leipzig)*, **27**, 243 (1936).
- [13] Y.C. Akgoz, and G.A. Saunders, *J. Phys. C*, **8** 1387 (1975).
- [14] Y.C. Akgoz, and G.A. Saunders, *J. Phys. C*, **8**, 2962 (1975).
- [15] B. Lenoir, F. Brochin, and J.-P. Michenaud, *Europhys. Lett.*, **58**, 93 (2002).
- [16] N.B. Brand, D.V. Gitsu, A.A. Nikolaeva, and Ya.G. Ponomarev, *Zh. Exp. Teor. Fiz.* **72**, 2332 (1977). [*Sov. Phys. JETP*, **45**, 1226 (1977)].
- [17] D. Gitsu, L. Konopko, A. Nikolaeva, and T. Huber, *Applied Physics Letters*, **86**, 10210 (2005).
- [18] Y.M. Lin, X.Z. Sun, M.S.Dresselhaus, *Phys. Rev. B* **62**, 4610 (2000).